



**NATIONAL COMMISSION FOR THE
CERTIFICATION OF CRANE OPERATORS (NCCCO)**

CANDIDATE HANDBOOK

- **SIGNALPERSON**



BOARD OF DIRECTORS

This handbook and application packet for the NCCCO signalperson certification program contains a Candidate Written and Practical Examination Application form. Please read this handbook carefully and retain it for reference throughout the certification process.

Do not discard this document.

PRESIDENT

Thom Sickelsteel

Barnhart Crane

VICE PRESIDENT

J. Kerry Hulse

Deep South Crane & Rigging

SECRETARY/TREASURER

Peter Juhren

Morrow Equipment Co.

IMMEDIATE PAST PRESIDENT

J. Chris Ryan

Boh Bros. Construction Co. (rtd.)

CHAIRMAN, COMMISSIONERS

Ellis Vliet

Turner Industries

Vinal George Bell

Cianbro Equipment

James T. Callahan

International Union of Operating Engineers

Pete Laux

Kiewit Companies

Tim Watters

Hoffman Equipment

CHIEF EXECUTIVE OFFICER

Graham J. Brent

National Commission for the
Certification of Crane Operators

NCCCO does not discriminate against any individual because of race, gender, age, creed, disability, or national origin.



This NCCCO certification program is accredited by the American National Standards Institute (ANSI) to ISO 17024—General requirements for bodies operating certification systems of persons.



ISO/IEC 17024
Personnel Certification Body
#0756

Mobile, Tower, Overhead,
Articulating, and Service Truck Crane
Operator, Digger Derrick Operator,
Signalperson, Rigger Level I and
Level II, Crane Inspector, and Lift
Director Programs Accredited

Dear NCCCO Signalperson Certification Candidate:

Welcome to the National Commission for the Certification of Crane Operators (NCCCO) national signalperson certification program.

NCCCO is a nonprofit organization founded in 1995 to establish a fair and independent evaluation of crane operator knowledge and skills. Key to this industry-led effort was the development of CCO Written and Practical Examinations leading to nationally recognized credentials, first for mobile crane operators, then for operators of other types of cranes. As personnel responsibilities in the lifting industry have become better defined, NCCCO has also developed certification programs for other occupations involved, including those for riggers and signalpersons.

This nationally recognized and internationally accredited signalperson certification program is the culmination of many years' hard work by experts from the varied industries and groups that use cranes, including construction, steel erection, ironworkers, operating engineers, utilities, and crane rental firms. The NCCCO task force that developed this program was made up of experts from all aspects of the crane industry—crane operators, ASME B30 members, signalpersons, training directors, managers, supervisors, insurance representatives—who together represent many thousands of hours of crane operating and signaling experience. These volunteers gave freely of their time and expertise with the goal of improving the safety of all whose work brings them into contact with cranes and lifting equipment.

Until recently signalperson certification was voluntary unless required by local jurisdictions or specific employers. However, in November 2010 the federal Occupational Safety and Health Administration (OSHA) enacted new national standards for cranes and derricks used in construction under 29 CFR 1926 Subpart CC. These new rules state that signalpersons need to be qualified (rather than certified) by a qualified evaluator and that certification by an organization such as NCCCO meets this requirement. Qualification can be either through a third-party qualified evaluator (such as an accredited certification body) or through an employer's qualified evaluator. All signalpersons must be qualified and tested through a written or oral test and a practical test, and the qualification must be documented. CCO signalperson certification meets this requirement.

To ensure CCO examinations are—and remain—valid measurements of crane operators' proficiency, NCCCO teamed the task force's knowledge and experience with its exam development expertise. In addition to guiding the development of new examinations, NCCCO continually analyzes the performance of CCO exams and reports to the Exam Management Committees. To be able to provide fair and independent assessments, NCCCO does not conduct training, nor does it provide training materials.

NCCCO, as a third-party certification body, is fully committed to, and understands the importance of, delivering all certification activities on a foundation of impartiality. All policies and procedures are established in an objective manner and ultimately strive to achieve fairness throughout all activities. NCCCO prevents any conflicts of interest through detailed policies and procedures observed by staff, governing body representatives, and those involved in written and practical exam administration.

This candidate handbook has been developed to provide you with comprehensive information about the CCO Written and Practical Examinations required to become a certified signalperson. NCCCO recognizes the commitment you are about to make, and we want your experience to be a positive and successful one. If, after reading this handbook, there is anything you do not fully understand or need clarified, please call NCCCO at 703-560-2391 or email info@nccco.org, and NCCCO staff will guide you through any aspects of the NCCCO national signalperson certification program that you would like explained in more detail.

Thank you for your interest—and good luck with your efforts to become CCO-certified!

This page intentionally left blank



Table of Contents

Introduction	1
Program Description	1
CCO Examination Development	1
Certification Policies	3
Eligibility.....	3
Experience	3
Signalperson Written Examination.....	3
Signalperson Practical Examination.....	3
Certification Time Frames	3
Recertification	3
Code of Ethics for Signalpersons	4
Disciplinary Policy	4
Substance Abuse Policy	4
Certification Cards.....	5
Change of Address	5
Written and Practical Examination Process	7
Application Process to Take the Signalperson Examinations.....	7
Paper/Pencil Testing (PPT) Option	7
Computer-Based Testing (CBT) Option.....	9
Test Site Information	11
Written Test Scoring Information	11
Practical Scoring.....	11
Practical Score Reporting.....	12
Retaking the Examination(s)	12
Information Release Policy	12
Written Examination Outline	13
Sample Questions	15
Reference List	16
Practical Examination Outline	17
Candidate Forms.....	19
Candidate Application—Written and Practical Examinations.....	21
Candidate Recertification Application	23
Change of Address Form.....	25
NCCCO Information Release Policy.....	26

This page intentionally left blank



Introduction

PROGRAM DESCRIPTION

The National Commission for the Certification of Crane Operators (NCCCO) is an independent, nonprofit organization formed to establish and administer a nationwide program of certification for crane operators and associated personnel. NCCCO sets standards for measuring the knowledge and proficiency required for the safe operation of cranes, including signaling of mobile and tower cranes.

Based on extensive discussions with representatives from all segments of business and industry who recognize the impact of safety issues, NCCCO has identified the following potential benefits of signalperson certification:

- Fewer accidents, injuries, and fatalities
- Assurance of signalperson's abilities
- Reduced risk of loss
- Less property damage
- Improved safety records
- Enhanced public image of signalpersons

All signalperson candidates are required to pass both the Written and Practical Examination(s) to be certified.

The initial certification period is for five years, after which a signalperson is required to recertify. Periodic practical examination is necessary to ensure that certificants' knowledge of industry standards, equipment, and safety practices keeps pace with changes in these areas. NCCCO's subject matter experts, working in conjunction with psychometric consultants, reviewed the speed of such change in the industry and researched other comparable certification and licensing programs before determining that this goal could be achieved by setting the examination interval at five years; little, if any, additional benefit, it is believed, would accrue by more frequent testing. A written examination is not required for recertification.

CCO EXAMINATION DEVELOPMENT

The first step in the development of an objective test is to identify the knowledge necessary for safe signaling of crane operations. A representative number of crane operators and signalpersons then validated that the knowledge recommended by the experts is vital to safe operations. The content specifications and test blueprints were then generated from the validation study.

Development of the *Signalperson Written Examination* involved a panel of crane operation content experts who worked with NCCCO staff to write and review all questions used in the examination. Each examination contains a

unique combination of questions from the question bank. These questions are selected for the examination on the basis of the content areas defined by the test blueprints.

The *Signalperson Practical Examination* was developed as a fair and objective assessment of the essential skills a signalperson needs to signal mobile and tower crane operations safely.

These exams were developed over a one-year period by an NCCCO task force made up of experts from all aspects of the crane industry—crane operators, signalpersons, training directors, managers, supervisors, manufacturers, and ASME B30 members—who together represent many thousands of hours of crane operating experience.

The NCCCO task force teamed its knowledge and experience with NCCCO's exam development expertise, and NCCCO guided the NCCCO task force in establishing key elements of the program, including identifying essential skills, selecting tasks, standardizing test conditions, developing the scoring process, establishing reliability among tests, and creating flexible application and scheduling procedures.

In concert with the task force, NCCCO also designed the Practical Examiner Accreditation Program whereby NCCCO trains and accredits CCO-certified signalpersons to administer CCO Practical Examinations.

This page intentionally left blank



Certification Policies

SIGNALPERSON PROGRAM

This information is specific to the signalperson program; information regarding other CCO certification programs is covered in their respective candidate handbooks.

ELIGIBILITY

To be eligible for CCO signalperson certification, candidates must:

- Be at least 18 years of age
- Comply with NCCCO Substance Abuse Policy
- Pass a Written Examination
- Pass a Practical Examination
- Comply with the Code of Ethics for Signalpersons

EXPERIENCE

CCO certification examinations are designed for signalpersons who are trained and who use hand and voice signals in crane operations.

SIGNALPERSON WRITTEN EXAMINATION

The Signalperson Written Examination consists of 60 multiple-choice questions. Candidates are allowed 60 minutes to complete the examination.

Written exams may be taken as either paper/pencil tests (PPT), see page 7 for details, or computer-based tests (CBT), see page 9 for details.

SIGNALPERSON PRACTICAL EXAMINATION

The Signalperson Practical Examination requires the candidate to demonstrate proficiency in giving both hand signals and voice commands. The practical exam also assesses the candidate's understanding of crane dynamics and crane operations per OSHA 1926 Subpart CC.

CERTIFICATION TIME FRAMES

Candidates must pass both Written and Practical Examinations to be certified for a five-year period. The Written and Practical Exams may be taken in either order. Candidates have 12 months from the time they pass their first Written or Practical Exam in which to pass the corresponding (Written or Practical) Exam.

Any tests passed within a 12-month period count towards certification. For example, a candidate who fails the Signalperson Written Exam in January 2015 but passes the Signalperson Practical Exam in June 2015 has until June 2016 to retake (and pass) the Signalperson Written Exam.

If a certified Signalperson subsequently becomes certified as a Rigger Level I and/or Rigger Level II by taking the

appropriate written and practical exams, the certification period for the additional designation(s) expires at the same time his/her original certification (i.e., all rigger and signalperson designations expire on the same date, regardless of when in the five-year certification period the candidate passed them). If the new designation(s) is added within the final 24 months of his/her certification period, the certificant is exempt from recertifying for the new designation(s) after five years; after that, however, certificants must recertify for all designations during the 12 months prior to their certifications' expiration date. This ensures that all of the certificant's rigger and signalperson designations maintain the same expiration date.

RECERTIFICATION

CCO certification is valid for five years. Candidates must complete *all* of their recertification requirements during the 12 months prior to their certification's expiration date.

Recertification requirements include:

- Passing the Recertification Practical Examination
- Compliance with the NCCCO Substance Abuse Policy
- Compliance with the Code of Ethics for Signalpersons

Recertification candidates are allowed two attempts to pass the Signalperson Recertification Practical Exam before their certification expires. Candidates who are unsuccessful after two attempts must take and pass the regular Signalperson Practical Exam.

Certified candidates may take their Recertification Practical Examination up to one year prior to their certification's expiration date. Regardless of the date of the recertification examination within that one-year period, the new five-year certification period begins from the date of expiration of the candidate's initial certification.

[Note: Candidates who recertify more than 12 months prior to their certification's expiration date will have their new certification period begin immediately, not from the end of their current certification period.]

Recertification exams are available at regularly scheduled test administrations. Candidates who want to recertify should contact the Test Site Coordinator who set up their initial certification exams. Candidates whose employment circumstances have changed should ask their new employer to schedule a practical test administration or visit the NCCCO website for a schedule of upcoming open Test Sites.

CODE OF ETHICS FOR SIGNALPERSONS

CCO-certified signalpersons must comply with the Code of Ethics for Signalpersons during their certification period, as defined below.

In my occupation, I will conduct myself in a manner:

- i. *So as to place the safety and welfare of others associated with my work above all other considerations;*
- ii. *So as to protect and preserve nearby general public property and the environment; and*
- iii. *So as to be free of bias with regard to religion, ethnicity, gender, age, national origin, and disability.*

Furthermore, in connection with my work and in my dealings with NCCCO, I will:

- iv. *Make management and appropriate personnel aware promptly if I have any safety concerns relating to the work that I am performing or with which I am involved;*
- v. *Not knowingly violate any safety-related regulations, warnings, or instructions set forth by OSHA, recognized safety standards, prevailing jurisdictions, or equipment manufacturers; and,*
- vi. *Not mislead, misrepresent or knowingly deceive others concerning my experience or the capabilities of myself or the equipment I am operating or with which I am working.*

In addition, in my dealings with NCCCO, I will:

- vii. *Provide accurate and complete information and abide by NCCCO's policies and procedures, including this Code of Ethics, as they may be updated from time to time;*
- viii. *Not act dishonestly or unfairly in order to gain an advantage, or to provide another with an advantage, in connection with any dealings with NCCCO;*
- ix. *Cooperate fully and completely with any administrative inquiries or investigations by NCCCO; and,*
- x. *Not misrepresent or misuse any NCCCO card, or the NCCCO or CCO acronyms and logos, or any registered trademark or other intellectual property of NCCCO; and I understand that I must return the card to NCCCO immediately if required to do so.*

CCO-certified personnel who intentionally or knowingly violate any provision of the Code of Ethics will be subject to action by a peer review panel, the Ethics and Discipline Committee, which may result in suspension or revocation of certification.

DISCIPLINARY POLICY

NCCCO's Ethics and Discipline Committee is responsible for establishing and implementing standards of conduct, such as ethical standards and policies and procedures for disciplinary action. Grounds for revocation of certification status include, but are not limited to, the following:

1. Period of certification exceeded without renewal
2. Evidence of falsification of any information on any documents submitted to NCCCO or its agents
3. Evidence of non-compliance with NCCCO's Substance Abuse Policy
4. Evidence of culpability in an accident during certification period
5. Evidence of non-compliance with the Code of Ethics

NCCCO has established policies and procedures to address alleged violations of the Code of Ethics fairly and consistently. The complaint procedures have been designed to ensure that only valid and actionable complaints are considered and investigated; they also ensure that all parties involved in the complaint have an opportunity to document circumstances warranting the complaint and to respond to the complaint.

NCCCO has a two-tier process to ensure that issues regarding the practice and conduct of certified signalpersons are fairly and reasonably investigated and determined; this process also ensures that the public is protected against unprofessional and unethical conduct by certificants. Complaints against certificants are initially investigated by NCCCO's Manager of Test Integrity, who reports to NCCCO's Ethics and Discipline Committee. If the complaint is considered actionable, the Ethics and Discipline Committee informs both the certificant and the complainant of the official opening of the investigation.

Following the investigation of the complaint, the Ethics and Discipline Committee informs the certificant and the complainant of its decision. If a sanction is imposed, the certificant may request an appeal of the decision to the NCCCO Board of Directors.

All appeals should be addressed to:

Chief Executive Officer
National Commission for the Certification of Crane Operators (NCCCO)
2750 Prosperity Avenue, Suite 505
Fairfax, VA 22031

The decision of the NCCCO Board of Directors is final.

SUBSTANCE ABUSE POLICY

It is the policy of NCCCO that signalpersons shall not use a prescribed or over-the-counter substance that would impair their ability to signal cranes safely. This includes illegal drugs, controlled substances (including trace amounts), look-alike drugs, designer drugs, or any other substance that may have an effect on the human body of being a narcotic, depressant, stimulant, or hallucinogen.

An exception to this rule is that a signalperson may use such a substance or drug if it is prescribed by a licensed medical practitioner who is familiar with the signalperson's medical history and all assigned duties and who has advised the signalperson that the prescribed substance or drug will not adversely affect the signalperson's ability to signal a mobile or tower crane safely.

CCO-certified signalpersons shall comply with the substance abuse testing provisions of ASME B30.5. It is a condition of certification that signalpersons certified by NCCCO attest to their compliance with this Substance Abuse Policy. Non-compliance with this policy automatically revokes a candidate's certification status.

CERTIFICATION CARDS

Certified signalpersons receive a laminated photo ID card at no cost when they certify for the first time and when they complete the requirements for recertification.

Replacement cards, cards showing certification in an additional designation, or updated cards for candidates who retake and pass a designation they previously failed may be obtained from NCCCO at a cost of \$25.

Updated or replacement cards can be ordered online at: www.nccco.org/newcard.

CHANGE OF ADDRESS

Certificants who change their address must notify NCCCO as soon as possible. Failure to do so may cause important updates on NCCCO's programs to be missed that could affect a certificant's status.

Changes of address should be sent to NCCCO in writing (via letter or fax). A form is provided for this purpose in this handbook.

This page intentionally left blank



Written and Practical Examination Process

APPLICATION PROCESS TO TAKE THE SIGNALPERSON EXAMINATIONS

Signalperson Written and Practical Exams may be taken at an approved NCCCO test site. Candidates may also test on only the Signalperson Written Exam at any NCCCO paper/pencil (PPT) sites or computer-based testing (CBT) sites at approximately 300 PSI test centers across the country. The content of both test formats is identical; see the appropriate sections below for instructions on how to apply for either paper/pencil testing or CBT exams.

Candidates Requesting Testing Accommodations

Arrangements for persons with disabilities will be provided upon request, in conformance with the Americans with Disabilities Act (ADA).

Professional documentation in support of a request for accommodation must be submitted to NCCCO no later than four weeks prior to the scheduled test date. For further information about testing accommodations, see the complete NCCCO Testing Accommodations Policy at: www.nccco.org/accommodations.

PAPER/PENCIL TESTING (PPT) OPTION

Candidates desiring to sit for paper/pencil written exam(s) should visit www.nccco.org/testsites to see a schedule of upcoming Test Dates and Locations and then submit a completed Candidate Application form with the appropriate documentation as directed on the form. Applications are due two weeks prior to the scheduled examination date. PPT application deadline examples are shown on page 8. Information about the specific locations of the Test Sites will be available approximately one to three months prior to the examination. Candidates eligible to sit for the examination will receive an admission letter approximately one week before the scheduled test administration date.

Submission of Application

To apply for paper/pencil exams, use the Candidate Application form at the back of this handbook. The Candidate Application with the appropriate fees, as well as any correspondence and requests for information concerning the administration of CCO examinations, should be sent to:

NCCCO—Testing Services Department
4141 S. Highland Drive, Suite 225
Salt Lake City, Utah 84124
Phone: 727-449-8525
Fax: 801-938-9540

Contact the Test Site Coordinator to confirm whether the application should be sent to the Test Site Coordinator or directly to NCCCO. Check the application to ensure that all information provided is accurate and complete. In addition to the completed application, make sure that the appropriate fees are enclosed.

Candidates may also submit applications and payment online for either PPT or CBT exams at: www.nccco.org.

Candidates must follow the directions carefully when filling in the required information. Incomplete applications, incorrect payment, and/or inaccurate documentation will delay the processing and incur additional fees. This could result in *NOT* being able to sit for the examination(s).

Deadlines

Please note that all deadlines are UPON RECEIPT deadlines. Candidates and Test Site Coordinators are solely responsible for making sure that completed and accurate applications reach NCCCO by the stated deadlines.

Examination Fees

For paper/pencil tests (PPT), the appropriate Written Exam fees must be enclosed with the Candidate Application. Checks, money orders, or credit cards (VISA, MasterCard, or American Express) may be used; do not send cash. Please include payment in the envelope with all the other application materials.

All returned checks are subject to a \$30 fee.

PPT Written Exam/Retest Fees:

Exam Fees/Retest Fees for Signalperson candidates (not current CCO card holders):

- Signalperson Written Exam \$95
- Signalperson Practical Exam \$95

Combined Signalperson & Rigger Level I Fees (not current CCO card holders):

- Signalperson & Rigger Level I Written and Practical Exams\$250*

Exam Fees for current CCO card holders:

- Signalperson Written Exam \$75
- Signalperson Practical Exam \$50

Combined Signalperson & Rigger Level I Fees (current CCO card holders):

- Signalperson & Rigger Level I Written and Practical Exams\$225*

Retest fees for current CCO card holders:

- Signalperson Written Exam \$50
- Signalperson Practical Exam \$50

**To receive discounted pricing, all written exams must be taken at the same test administration. All Practical Exams must be completed within seven days of the Written Exam administration or exam fees will be forfeited.*

Recertification Exam/Retest Fees:

Recertification Exam Fees/Retest Fees for CCO-certified Signalpersons only

- Signalperson Recertification Practical Exam \$95

Recertification Exam Fees for CCO-certified Operators only

- Signalperson Recertification Practical Exam..... \$75

Recertification Exam Retest Fees for CCO-certified Operators only

- Signalperson Recertification Practical Exam..... \$50

Other Fees:

An additional \$50 late fee will be charged if the application is late.

An additional \$25 will be charged if a candidate:

- Wishes to reschedule without a valid reason (see Emergency Cancellations or Withdrawals)
- Needs a replacement or updated certification card or score report

An additional \$30 fee will be charged if:

- An application form is incomplete
- Full payment is not received or a check is returned
- A credit card cannot be processed for any reason
- A candidate wants to add to (or change) the exams he/she plans to take after scheduling has been completed (in addition to the exam fee)

All application materials must be received at NCCCO's office according to the sample test schedule outlined under "Application Deadlines."

Applications received after the main application deadline, but at least four business days prior to the exam administration deadline, may be accepted for an additional \$50 late fee. For example, for a test administration on a Saturday, late applications that arrive at NCCCO's testing office by 5 p.m. (ET) on the Monday evening prior will be accepted. Candidate Applications that arrive after that time cannot be accepted.

Walk-in candidates cannot be accepted under any circumstances.

Rescheduling, Cancellations, and Withdrawals

Should a candidate be unable to sit for the examination, NCCCO **must receive notification in writing no later than seven business days prior to the examination date.** Candidate fees will be held up to one year. When the candidate reschedules, he/she will need to pay an additional \$25 rescheduling fee.

When the candidate is ready to reschedule his/her Written Examination, he/she **must** notify NCCCO and submit the necessary documentation and fees by the deadline for the rescheduled test date.

Candidates withdrawing or canceling after the deadline or not sitting for the examination will forfeit all application fees and will NOT receive a refund.

Length of Test Day

CCO written exams are carefully designed to provide a reliable and valid assessment of a candidate's knowledge and skills. Time limits are carefully determined for each written exam to allow enough time for a prepared candidate to complete the exam and to provide for an efficient and successful administration of all exams to scheduled candidates on testing day.

To provide each candidate with a fair and standardized administration of the written examination(s), and to ensure the reliability and validity of the written examinations is maintained, it is not recommended that a candidate schedule written exams totaling more than six hours of testing time on the same day.

Emergency Cancellations or Withdrawals

ONLY the following situations will be accepted as grounds for emergency cancellations or withdrawals:

- **Called to work**—supporting documentation required: *letter from employer*
- **Candidate illness**—supporting documentation required: *doctor's note*
- **Family death**—supporting documentation required: *death certificate or obituary notice*

Requests for medical and personal emergency withdrawals are handled by NCCCO's Testing Services Department upon submission of a letter describing the situation. Full name, address, and social security number must be included along with the scheduled test date, site number, and supporting documentation indicated above.

NCCCO **MUST** receive written notification within seven business days after the scheduled examination date or all application fees will be forfeited. Candidates will, however, be allowed to reschedule for a future examination administration.

Candidates will **NOT** receive a refund if they decide they no longer wish to take the test.

Test Administration Schedule for CCO Examinations

Paper/pencil CCO Written Examinations are available for administration on demand with at least four weeks' notice.

Application Deadlines

Tests can be administered at any time as long as the application deadlines are met. Sample deadlines shown are for a test date of January 29.

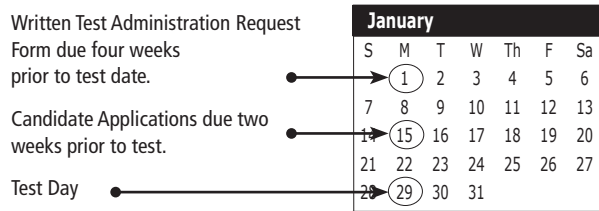

Admission Letters

For paper/pencil exams, approximately one week before the scheduled test date, registered and eligible candidates approved to take CCO Written Examination(s) will receive an admission letter by mail. The admission letter contains information regarding the test center address, the reporting time, the examination(s) the candidate is registered for, and the materials candidates need to bring with them on the day of the administration. This admission letter should be presented at the Test Site to gain admittance to the examination(s).

Identification at the Test Site

Candidates must bring valid photo identification to the test site on the day of the test administration. Candidates will be required to sign the test site roster upon entry to the testing area.

Acceptable forms of photo identification for paper/pencil tests are a current:

- Passport
- Government-issued driver's license
- Military identification card
- U.S. Government-issued alien registration card
- Work identification

NOTE: Candidates without appropriate identification documents will NOT be admitted to take the CCO Written Examination(s) and all fees will be forfeited.

Materials to Bring to the Test Site

Each candidate must bring the following items to the Test Site:

- Photo identification
- Admission letter for the specific test date (recommended)
- Two sharpened #2 pencils (to complete the examination answer sheet)
- A good eraser

NOTE: No books, scratch paper, calculators, reference materials, beepers, cellular phones, or other personal items will be allowed in the examination room.

Score Reporting

Paper/pencil CCO Written Examinations are electronically scored by NCCCO. For this reason, it is important to complete the answer sheet according to the instructions provided by the Chief Examiner on the day of the exam. Candidates will receive credit only for answers recorded on the scannable answer sheet. **Answers marked in the test booklet(s) will NOT be counted toward a candidate's score.**

All candidates will receive a score report of their performance. Examination results are mailed to candidates approximately 12 business days after the examination administration.

COMPUTER-BASED TESTING (CBT) OPTION

Candidates desiring to take their written exam(s) using the computer-based testing (CBT) option should visit nccco.org and click on "Find CCO Test Locations" on the left menu and then "Computer-Based Testing" (www.nccco.org/cbt). This page includes links to a directory of approximately 300 PSI locations throughout the U.S. as well as the online application form.

Online applications may be completed and submitted at any time. Candidates should apply to take CBT exam(s) as soon as possible, but no later than five business days before their preferred exam date. Please note that site availability is not guaranteed on the preferred exam date, and availability can only be confirmed when scheduling the appointment.

After the candidate completes and submits the online application (with payment), an authorization email will

be sent within 48 hours. **After receiving the authorization email, the candidate must wait 24 hours.** Then the candidate must call the number provided in the email to schedule the test(s) with PSI; the PSI customer service representative will do his/her best to select a test date and location convenient for the candidate. PSI will send an appointment confirmation email within 24 hours. The candidate must then go to the selected test center at the scheduled date and time.

CBT Examination Fees

Candidates must pay the appropriate CBT Written Exam fees when they apply online. A credit card (VISA, MasterCard, or American Express) must be used to pay online. CBT exam payments are valid for one year. If the candidate does not schedule and test within 12 months, he/she forfeits the fees. This does not affect the deadline(s) noted in the CCO Certification Time Frames or the Recertification Requirements sections.

CBT Written Exam/Retest Fees:

- Signalperson Written Exam or Retest (*not current CCO card holder*) \$130
- Signalperson Written Exam (*current CCO card holder*) \$110
- Signalperson Written Exam Retest (*current CCO card holder*) \$85

Other Fees:

An additional \$25 will be charged if a candidate:

- Needs an updated or replacement certification card or score report

An additional \$30 fee will be charged if:

- An application form is incomplete (e.g., name misspelled or does not match name on valid photo ID)
- A credit card cannot be processed for any reason
- Any changes are requested after submitting the application

NOTE: After the candidate has scheduled his/her appointment with PSI, no changes can be made. If the name for the scheduled appointment does not match that on the photo ID presented, all fees will be forfeited.

Rescheduling, Cancellation, or Withdrawal

CBT candidates may cancel and reschedule an examination appointment without forfeiting their fees if their cancellation notice is received at least 24 hours before the scheduled examination date.

Candidates will NOT receive a refund if they no longer wish to take the test.

NOTE: A voice mail message is not an acceptable form of cancellation. Please call PSI at 800-211-2754 to speak with a PSI customer service representative.

Missed Appointment or Late Cancellation

A candidate’s registration will be invalidated and the examination fee(s) will be forfeited if he/she:

- Does not cancel the appointment more than 24 hours before the scheduled examination date
- Does not appear for his/her examination appointment
- Arrives after examination start time
- Does not present proper identification

Identification at the Test Site

Candidates must bring photo identification to the test site on the day of the test administration. Candidates will be required to sign the test site roster upon entry to the testing area.

Acceptable forms of photo identification for computer-based tests are a current:

- Passport
- U.S. government- or state-issued driver’s license
- Military identification card
- U.S. government-issued alien registration card

NOTE: Candidates without appropriate identification documents will NOT be admitted to take the CCO Written Examination(s) and all fees will be forfeited. Work identification is NOT acceptable for computer-based testing centers.

Materials to Bring to the Test Site

Each candidate must bring the following items to the test site:

- Valid photo identification
- Confirmation email from PSI (recommended)

NOTE: No books, scratch paper, calculators, reference materials, beepers, cellular phones, or other personal items will be allowed in the examination room.

Score Reporting

CBT candidates receive their test results immediately following their exams and should retain these score reports for their records.

TEST SITE INFORMATION (BOTH PPT AND CBT)

Test Security

For the purposes of test security, candidates who sit for CCO examination(s) acknowledge that they understand the following:

- The examination is the exclusive property of NCCCO.
- The examination and the questions contained therein are protected by federal copyright law. No part of the examination(s) may be copied or reproduced in part or whole by any means whatsoever, including memorization.
- Theft or attempted theft of an examination booklet or any of its pages is punishable as a felony.
- Candidate participation in any irregularity during the examination, such as giving or obtaining unauthorized information or aid, as evidenced by an observation or subsequent statistical analysis, may be sufficient cause to terminate participation, invalidate the results of the examination, or other appropriate remedy.
- Candidates verify that they have successfully met the physical/medical requirements and are eligible to take this examination. If at any time it is confirmed that a candidate has not met all the requirements, the candidate will no longer be eligible for certification.
- A candidate's signature on the answer sheet for the administration of the examination confirms that the candidate has read and understands the above statements.

Candidate Question Comment Forms

Candidates can comment on the examination(s) as a whole or on specific items within an examination by writing their comments on the Candidate Question Comment Form. Written comments should reference the question number as well as the site code and the test date and should accompany the examination. Examination comments are reviewed by NCCCO content experts on a regular basis. An online form is available for computer-based tests.

NOTE: Only comments completed on the Candidate Question Comment Form at the Test Site will be considered for review.

WRITTEN TEST SCORING INFORMATION

CCO Written Examinations are criterion-referenced examinations; i.e., the passing score is set beforehand, and candidate performance on the examination is not compared to the performance of others taking the

examination. In a criterion-referenced examination, a candidate must obtain a score equal to or higher than a predetermined passing score to pass the test. The passing scores represent absolute standards and are determined by panels of NCCCO content experts using a psychometrically accepted standard-setting methodology.

In reporting the examination results to candidates, statistical procedures are used to convert raw scores (i.e., the number of test questions answered correctly) to scaled scores, which are set for all administrations of the examination(s). The scaled score is not a number-answered-correctly score.

Candidate results are reported on a scale ranging from zero to 100 points, with a score of **70** representing the minimum passing score for this test. Written exam score reports include a strength and weakness report by content domain.

Candidate scores cannot be given over the telephone.

Hand Score Requests

Candidates not passing exam(s) may request from NCCCO a hand scoring of their answer sheet(s), provided their request is made in writing within three months of the test date. Hand-scoring requests must be accompanied by a processing fee of \$25 for one test score or \$50 for two or more failed test scores per test administration. Requests should be mailed to:

NCCCO—Testing Services Department
1960 Bayshore Blvd.
Dunedin, Florida 34698
Phone: (727) 449-8525
Fax (727) 461-2746

In the event that the hand scoring of a failing candidate's answer sheet results in a passing score, the hand-scoring fee will be refunded in full.

PRACTICAL SCORING

Candidate performance on the Practical Examinations is recorded by Practical Examiners accredited by NCCCO. Examiner requirements include meeting NCCCO requirements for certification, passing the Written and Practical Exams, and successfully completing an accreditation workshop.

The testing procedure has been developed to provide the highest degree of standardization and reliability. The Examiner's task is primarily to record the performance of the candidate.

A candidate may lose points either by giving an incorrect signal, or giving a signal not in accordance with the Standard Method Hand Signals. Candidates' performances are scored off site at NCCCO facilities.

PRACTICAL SCORE REPORTING

All candidates receive score reports of their performance. Examination results are mailed to candidates approximately 12 business days after the receipt of Practical Examination score sheets by NCCCO.

Please note that while Practical Examiners are encouraged to expedite score sheets after each test administration, they may batch score sheets from several test administrations over a number of days. This means that candidates may receive their score reports from NCCCO more than three weeks after their test administration.

Both the Practical Examination and the scoring system have been validated and verified by NCCCO's pilot testing program. A score of **75** represents the minimum passing score for Signalperson Practical Examination.

RETAKING THE EXAMINATION(S)

Candidates who fail an examination(s) may retake the examination(s) by reapplying and paying all corresponding fees. CBT candidates may reapply any time after taking their exam(s); however, the new authorization email will be delayed pending the receipt of the exam results from PSI, which normally takes approximately 72 hours.

INFORMATION RELEASE POLICY

NCCCO releases information pertaining to individuals who have successfully passed one or more CCO examinations according to its Information Release Policy (see page 26).



Written Examination Outline

SIGNALPERSON

The Written Examination for the CCO signalperson certification program tests the following knowledge areas:

Domain 1: Hand Signals

- Approximately 33% of test

Domain 2: Voice Communication

- Approximately 13% of test

Domain 3: Basic Knowledge of Crane Operations

- Approximately 27% of test

Domain 4: Situational Awareness (Site-Specific Considerations)

- Approximately 13% of test

Domain 5: Safety Standards and Regulations

- Approximately 13% of test

DOMAIN 1: HAND SIGNALS

Approximately 33% of test

1. Know the standard method hand signals for mobile cranes.
2. Know the standard method hand signals for tower cranes.
3. Understand the necessity of moving with the load while remaining visible to operator.
4. Know the importance of providing clear and visible hand signals.
5. Know the importance of keeping constant communication and understanding with the operator.

DOMAIN 2: VOICE COMMUNICATION

Approximately 13% of test

1. Know the proper use of the equipment being used, as well as its benefits and limitations.
2. Be aware of communication barriers, i.e. wind, language, interference.
3. Know the importance of ensuring fully charged batteries are used and the communication device is in acceptable working order.
4. Know the importance of keeping continuous communications and understanding with the operator.
5. Know the standard method pertaining to function/direction, speed and/or distance, and function/stop.

6. Understand the importance of operator perspective while swinging.
7. Know what action to take if the operator is not following signals correctly.

DOMAIN 3: BASIC KNOWLEDGE OF CRANE OPERATIONS

Approximately 27% of test

1. Know basic crane terminology and definitions.
2. Understand the effect of size, shape, weight, and center of gravity of load being lifted.
3. Understand boom deflection and how to compensate for it.
4. Know the effect a moving load has on a crane.
5. Understand that boom length, angle, and load weight may effect boom deflection.
6. Know the importance of keeping the hoist line vertical when a load is applied.
7. Understand what causes drift and how to compensate for it.
8. Know the effects of side loading.
9. Know the causes and consequences of two blocking.
10. Know the importance of keeping personnel from the load path.
11. Understand that when applying load to crane that center of gravity needs to be below the boom tip.

DOMAIN 4: SITUATIONAL AWARENESS (SITE-SPECIFIC CONSIDERATIONS)

Approximately 13% of test

1. Know the importance of reviewing lift requirements with site supervision/operator/crew.
2. Know how to identify and avoid hazards and obstacles.
3. Understand the effects of weather conditions.
4. Know how and when to use voice or hand signals.
5. Know emergency procedures.

DOMAIN 5: SAFETY STANDARDS AND REGULATIONS

Approximately 13% of test

1. Know the applicable OSHA and ASME standards, including but not limited to:
 - a. People under loads
 - b. Suspended personnel platforms
 - c. Hand signal posting requirements
2. Know electric power line hazards, applicable regulations, and safety practices.



Sample Questions

The following are sample test questions typical of the style and content of the questions used in the CCO Signalperson Written Examinations.

1. What is the purpose of an anti-two block device?
 - a. Prevents contact between the load block and the boom point
 - b. Shuts down all crane functions
 - c. Prevents contact between the load block and the auxiliary ball
 - d. Prevents boom hoist-up function

2. With the boom fully retracted, which series of standard method hand signals would be required to move the hook from Position #1 to Position #2?
 - a. Hoist, stop, telescope out, stop, lower the hook, stop
 - b. Swing right, stop, boom down, stop, lower the hook, stop
 - c. Extend the boom, stop, boom down, stop, lower the hook, stop
 - d. Hoist, stop, boom down, stop, lower the hook, stop

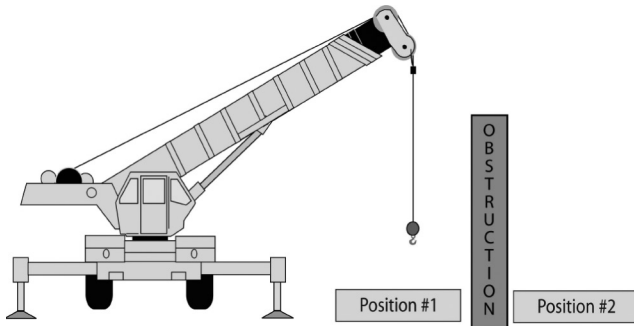

3. When signaling a tower crane, which of the following is most reliable?
 - a. Two-way radio
 - b. Hard-wire intercom
 - c. Standard hand signals
 - d. Hands-free cell phone

4. What occurs when a heavy load is lifted?
 - a. Boom sag
 - b. Line pull increases
 - c. Boom deflection
 - d. Boom strength decreases

5. What is the signalperson directing the crane operator to do?

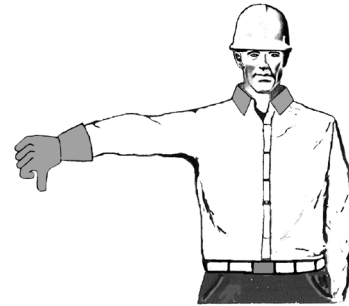

- a. Travel
 - b. Boom down and raise the load
 - c. Lower the load
 - d. Boom down
-
6. Which of the following describes the standard method hand signal to lower the hook?
 - a. With arm extended downward, forefinger pointing down, move hand in small horizontal circle.
 - b. Arm extended, fingers closed, thumb pointing downward.
 - c. With arm extended, thumb pointing down, flex fingers in and out as long as load movement is desired.
 - d. One fist in front of chest, thumb pointing outward and heel of fist tapping chest.

A	6
D	5
C	4
B	3
A	2
A	1
Answer #	Question #



Reference List

The following reference materials are used by NCCCO's Examination Committee to verify the accuracy of CCO test questions. (Prices shown current at press time.)

ASME, B30.5 (2011) \$89.00
Mobile and Locomotive Cranes

Order by Internet: <http://catalog.asme.org>

Order by Mail:

American Society of Mechanical Engineers
22 Law Drive, Box 2900
Fairfield, NJ 07007
ph: 800-843-2763; fax: 201-882-1717

Payments accepted: Check, VISA, MasterCard, American Express, Discover, Diner's Club

OSHA 29 CFR 1926 SUBPART CC—CRANES AND DERRICKS IN CONSTRUCTION

Download free PDF from:

http://www.osha.gov/FedReg_oshapdf/FED20100809.pdf

Applicable sections start on Federal Register page 48135 (page 231 in PDF).

NCCCO SIGNALPERSON REFERENCE MANUAL (05/14) \$29.50

Order book by Internet:
www.nccco.org/store

Download free PDF from:
www.nccco.org/signalperson-study-materials

This manual was created to assist candidates preparing to take the CCO signalperson certification examinations. The information contained in this manual has been compiled from a number of different sources. The sources and the relevant material selected for inclusion in the reference manual are as follows:

- ASME B30.5-2011 Mobile & Locomotive Cranes, Section 5-3.3: Signals
- ASME B30.3-2012 Construction Tower Cranes, Section 3-3.3: Signals
- OSHA 29 CFR Part 1926—Subpart CC: Cranes and Derricks Used in Construction (Sections 1419–1422, and 1428: Signalperson Requirements and Qualifications)
- Voice Signal Communication

Please note that candidates should be familiar with all sections of ASME B30.5–2011 and OSHA 1926 Subpart CC that are relevant to crane operations and signaling operations.



Practical Examination Outline

SIGNALPERSON

The following is an outline of the practical testing procedure, as provided to candidates at the time of testing.

CANDIDATE INSTRUCTIONS

The signalperson Practical Examination consists of 20 scenarios. There is no time limit for this examination. Candidates will typically complete the exam in approximately 15 minutes.

The Test Site Coordinator is responsible for setting the testing schedule. During the Practical Examination, candidates are under the direction of the Practical Examiner and must follow the Practical Examiner's directions at all times.

Only the candidate and Practical Examiner are allowed in the testing area.

Prior to testing, you will watch a short video showing a typical Practical Examination as well as the following instructions:

1. There are two types of scenarios for which you will be asked to demonstrate proper hand or voice signals:
 - a. **Match Scenario:** In these scenarios, you observe the crane performing certain functions and give the necessary hand or voice signal(s) that match or matches the function.
 - b. **Candidate-Initiated Scenario:** In these scenarios, you give the necessary hand or voice signals to initiate and direct crane movement.
2. All hand and voice signals must be given in accordance with OSHA 1926 Subpart CC. Where OSHA 1926 Subpart CC does not address a particular signal, ASME B30.5 and ASME B30.3 signals will be used (for example, one-handed telescoping boom signals).
3. Make sure to give only one signal at a time (unless giving a "move slowly" command).
4. Give all signals in a clear and precise manner.
5. Maintain the hand signal as long as the function is being performed. For voice signals, remember to maintain constant communication.
6. Remember to give *stop* signals whenever necessary.

NOTE: A proper *stop* hand signal is moving arm back and forth at least one time.

7. At no point in time will a signal be required that would result in an unsafe act. If at any time an unsafe act is being performed, immediately give an appropriate signal to stop the lift operation.

8. In scenarios where multiple signals are required, you must give all signals correctly to receive any points for that scenario (no partial credit).
9. During candidate-initiated scenarios, you will have up to five seconds to give the hand or voice signal.
10. During candidate-initiated scenarios, you will have **only** one attempt to reach the appropriate stopping area before giving the next function. You are not allowed to stop short and go further or go long and bring it back.
11. At the start of each scenario, the instructions will be shown on the screen and given verbally. You will be asked if you understand the instructions. Take time to make sure you understand the instructions before proceeding.
12. **Follow the instructions!** If you have any questions, ask the Examiner before beginning each scenario.

CANDIDATE ID AND SIGNATURE

Prior to beginning the examination, the Practical Examiner will ask you for a photo identification, which you must provide in order to test.

The Practical Examiner will ask if you have read the Candidate Instructions and will answer any questions you may have. You will be asked to sign your application indicating you understand the instructions for the test.

POST-TEST PROCEDURES

Once you have completed the Practical Examination:

- The Practical Examiner will record your performance.
- The Practical Examiner is not permitted to review your score sheet or discuss your performance on the test.
- Exam results will be mailed to you within approximately 12 business days of NCCCO's receipt of the score sheet.
- Once you have completed your test, you must leave the Test Site.

This page intentionally left blank



Candidate Forms

Please photocopy and complete all sides of the following forms when applying for CCO Written and Practical Examinations.

- **Candidate Application—Written and Practical Examinations: Rigger & Signalperson**
- **Candidate Recertification Application: Rigger & Signalperson**
- **Change of Address Form**

This page intentionally left blank



Candidate Application

WRITTEN (PAPER/PENCIL TESTS) & PRACTICAL EXAMINATIONS—RIGGER & SIGNALPERSON

Please type or print neatly.

FULL LEGAL NAME (as shown on driver's license)		First	Middle	Last	Suffix (Jr., Sr., III)
CCO CERTIFICATION NUMBER (if previously certified)	DATE OF BIRTH		CANDIDATE ID: (if previously tested)		
MAILING ADDRESS					
CITY		STATE	ZIP	COUNTRY	
PHONE	CELL		EMAIL		
COMPANY/ORGANIZATION				PHONE	
COMPANY MAILING ADDRESS					
CITY		STATE	ZIP	COUNTRY	
<input type="checkbox"/> I AM REQUESTING TESTING ACCOMMODATIONS IN COMPLIANCE WITH THE AMERICANS WITH DISABILITIES ACT (ADA). (For details on NCCCO's Testing Accommodations policy, please see www.nccco.org/accommodations .)					
WRITTEN TEST ADMINISTRATION # (contact Test Site Coordinator)			DATE YOU INTEND TO TEST (MM/DD/YYYY)	TEST SITE COORDINATOR	

Note: Written Exam applications received without a Written Test Administration Number will be marked incomplete and cannot be processed.

FILL IN the circles next to the exam(s) for which you are applying.

EXAM DESCRIPTION	INITIAL EXAM FEES	RETEST FEES
<i>New CCO certification candidates only (includes CCO card):</i>		
<input type="radio"/> Rigger Level I (652850) & Rigger Level II (652802) Written and Practical Exams*	<input type="radio"/> \$250	N/A
<input type="radio"/> Rigger Level I (652850) & Signalperson (652701) Written and Practical Exams*	<input type="radio"/> \$250	
<input type="radio"/> Rigger Level I Written Exam (652850)	<input type="radio"/> \$95	<input type="radio"/> One Exam \$95 <input type="radio"/> Two Exams \$190 <input type="radio"/> Three or Four Exams \$250
<input type="radio"/> Rigger Level I Practical Exam	<input type="radio"/> \$95	
<input type="radio"/> Rigger Level II Written Exam (652802)	<input type="radio"/> \$95	
<input type="radio"/> Rigger Level II Practical Exam	<input type="radio"/> \$95	
<input type="radio"/> Signalperson Written Exam (652701)	<input type="radio"/> \$95	
<input type="radio"/> Signalperson Practical Exam	<input type="radio"/> \$95	
<i>Current CCO card holders (includes CCO card):</i>		
<input type="radio"/> Rigger Level I (652850) & Rigger Level II (652802) Written and Practical Exams*	<input type="radio"/> \$225	N/A
<input type="radio"/> Rigger Level I (652850) & Signalperson (652701) Written and Practical Exams*	<input type="radio"/> \$225	
<input type="radio"/> Rigger Level I Written Exam (652850)	<input type="radio"/> \$75	<input type="radio"/> One Exam \$50 <input type="radio"/> Two Exams \$100 <input type="radio"/> Three Exams \$150 <input type="radio"/> Four Exams \$200
<input type="radio"/> Rigger Level I Practical Exam	<input type="radio"/> \$50	
<input type="radio"/> Rigger Level II Written Exam (652802)	<input type="radio"/> \$75	
<input type="radio"/> Rigger Level II Practical Exam	<input type="radio"/> \$50	
<input type="radio"/> Signalperson Written Exam (652701)	<input type="radio"/> \$75	
<input type="radio"/> Signalperson Practical Exam	<input type="radio"/> \$50	
<i>Other fees:</i>		
<input type="radio"/> Updated/Replacement CCO Card		\$25
<input type="radio"/> Candidate Late Fee		\$50
<input type="radio"/> Incomplete Application Fee (see Candidate Handbook for details)		\$30
TOTAL AMOUNT ENCLOSED		\$

*To receive discounted pricing, all written exams must be taken at the same test administration and all practical exams must be completed within seven days of the written exam date. For logistical reasons it is recommended that candidates take no more than four exams on the same day.

CANDIDATE APPLICATION (CONT'D)
WRITTEN & PRACTICAL EXAMINATIONS—RIGGER & SIGNALPERSON

CCO CERTIFICATION CARD

Candidates who meet all the requirements for certification in any one designation are issued a certification card at no charge. Replacement and updated cards are available for an additional fee; see panel below.

Please email a digital color photo (without hat or sunglasses) to **photos@nccco.org** and label it with your full name and birth date. Enclose with your application form any required payment based upon the information listed below.



A 1 3/8" X 1 3/4" passport color photo may be substituted for a digital photo; if submitting a passport photo, please give it to your Test Site Coordinator.

I declare that the foregoing statements and those in any required accompanying documentation are true. I understand and agree that my failure to provide accurate and complete information or abide by NCCCO's policies and procedures, including the Code of Ethics and Substance Abuse Policy, shall constitute grounds for the rejection of my application or denial or revocation of my certification. I understand that NCCCO reserves the right to verify any information in this application or in connection with my certification. I consent to NCCCO's release of any information regarding this application and my examination administration to third parties, consistent with NCCCO's Information Release Policy. I have received a copy of the NCCCO Candidate Handbook, have read it, and agree to be bound by it. I also agree to be bound by all NCCCO policies and procedures, as they may be amended from time to time, including without limitation those posted at nccco.org. I further attest that I am physically and mentally capable of safely operating equipment and/or demonstrating signals on the day of the Practical Examination. I understand and agree that any personal injury and/or property damage resulting from or caused in any way by my participation in the CCO Practical Examination is not and shall not be the responsibility of NCCCO. I understand that if at any point during my certification period I fail to meet any of the requirements outlined above, or if matters arise that can affect my capability to continue to fulfill certification requirements, I must report it to NCCCO immediately and agree to cooperate with any subsequent investigation regarding such matters.

CANDIDATE SIGNATURE	DATE
---------------------	------

METHOD OF PAYMENT FOR CANDIDATE EXAMINATION FEES

Do not send cash.

<input type="checkbox"/>		<input type="checkbox"/>		<input type="checkbox"/>		<input type="checkbox"/>	Personal check enclosed	<input type="checkbox"/>	Employer check enclosed	<input type="checkbox"/>	Money order enclosed	<i>Please do not staple your check or money order.</i>
--------------------------	---	--------------------------	---	--------------------------	---	--------------------------	-------------------------	--------------------------	-------------------------	--------------------------	----------------------	--

If paying by credit card, complete the following information:

CREDIT CARD NUMBER	<table border="1" style="width: 100%; border-collapse: collapse;"> <tr> <td style="width: 2%;"> </td><td style="width: 2%;"> </td><td style="width: 2%;"> </td><td style="width: 2%;"> </td><td style="width: 2%;"> </td><td style="width: 2%;"> </td><td style="width: 2%;"> </td><td style="width: 2%;"> </td><td style="width: 2%;"> </td><td style="width: 2%;"> </td><td style="width: 2%;"> </td><td style="width: 2%;"> </td><td style="width: 2%;"> </td><td style="width: 2%;"> </td><td style="width: 2%;"> </td><td style="width: 2%;"> </td><td style="width: 2%;"> </td><td style="width: 2%;"> </td><td style="width: 2%;"> </td> </tr> </table>																				EXPIRATION DATE	<table border="1" style="width: 100%; border-collapse: collapse;"> <tr> <td style="width: 2%;"> </td><td style="width: 2%;"> </td><td style="width: 2%;"> </td><td style="width: 2%;"> </td> </tr> </table>				

NAME (Print as it appears on card)	SIGNATURE (on card)	SECURITY CODE*
------------------------------------	---------------------	----------------

* Three- or four-digit code located on the card.

Checks and money orders should be payable to: NCCCO

Please send application and payments to:

NCCCO—Testing Services Department
 4141 S. Highland Drive, Suite 225
 Salt Lake City, Utah 84124

 Phone: 727-449-8525
 Fax: 801-938-9540
 Email: jhorrocks@nccco.org



Candidate Recertification Application

WRITTEN (PAPER/PENCIL TESTS) & PRACTICAL EXAMINATIONS—RIGGER & SIGNALPERSON

Please type or print neatly.

FULL LEGAL NAME (as shown on driver's license)		First	Middle	Last	Suffix (Jr., Sr., III)
CCO CERTIFICATION NUMBER (if previously certified)		DATE OF BIRTH		CANDIDATE ID: (if previously tested)	
MAILING ADDRESS					
CITY			STATE	ZIP	COUNTRY
PHONE		CELL		EMAIL	
COMPANY/ORGANIZATION				PHONE	
COMPANY MAILING ADDRESS					
CITY			STATE	ZIP	COUNTRY
<input type="checkbox"/> I AM REQUESTING TESTING ACCOMMODATIONS IN COMPLIANCE WITH THE AMERICANS WITH DISABILITIES ACT (ADA). (For details on NCCCO's Testing Accommodations policy, please see www.nccco.org/accommodations .)					
WRITTEN TEST ADMINISTRATION # (contact Test Site Coordinator)			DATE YOU INTEND TO TEST (MM/DD/YYYY)		TEST SITE COORDINATOR

Note: Written Exam applications received without a Written Test Administration Number will be marked incomplete and cannot be processed.

FILL IN the circles next to the exam(s) for which you are applying.

EXAM DESCRIPTION	INITIAL EXAM FEES	RETEST FEES
Recertification Exams—Signalperson and/or Rigger certified only (includes card):		
<input type="radio"/> Rigger Level I Recertification Written Exam (652851)	<input type="radio"/> One Exam \$95	<input type="radio"/> One Exam \$95
<input type="radio"/> Rigger Level II Recertification Written Exam (652833)	<input type="radio"/> Two Exams \$190	<input type="radio"/> Two Exams \$190
<input type="radio"/> Signalperson Recertification Practical Exam (777702)		
Recertification Exams—current CCO-certified crane operators (includes card):		
<input type="radio"/> Rigger Level I Recertification Written Exam (652851)	<input type="radio"/> One Exam \$75	<input type="radio"/> One Exam \$50
<input type="radio"/> Rigger Level II Recertification Written Exam (652833)	<input type="radio"/> Two Exams* \$125	<input type="radio"/> Two Exams \$100
<input type="radio"/> Signalperson Recertification Practical Exam (777702)		
Note: Individuals recertifying for Rigger Level II are NOT required to take the Rigger Level I recertification exam.		
Additional Exams (new certifications)*:		
<input type="radio"/> Rigger Level I Written Exam (652850)	<input type="radio"/> One Exam \$50	<input type="radio"/> One Exam \$50
<input type="radio"/> Rigger Level I Practical Exam	<input type="radio"/> Two Exams \$100	<input type="radio"/> Two Exams \$100
<input type="radio"/> Rigger Level II Written Exam (652802)	<input type="radio"/> Three Exams \$150	<input type="radio"/> Three Exams \$150
<input type="radio"/> Rigger Level II Practical Exam	<input type="radio"/> Four Exams \$200	<input type="radio"/> Four Exams \$200
<input type="radio"/> Signalperson Written Exam (652701)		
<input type="radio"/> Signalperson Practical Exam		
Other fees:		
<input type="radio"/> Updated/Replacement CCO Card		\$25
<input type="radio"/> Candidate Late Fee		\$50
<input type="radio"/> Incomplete Application Fee (see Candidate Handbook for details)		\$30
TOTAL AMOUNT ENCLOSED		\$ <input style="width: 100px;" type="text"/>

***To receive discounted pricing, all written exams must be taken at the same test administration and all practical exams must be completed within seven days of the written exam date. For logistical reasons it is recommended that candidates take no more than four exams on the same day.**

CANDIDATE RECERTIFICATION APPLICATION (CONT'D)

RIGGER & SIGNALPERSON



I declare that the foregoing statements and those in any required accompanying documentation are true. I understand and agree that my failure to provide accurate and complete information or abide by NCCCO's policies and procedures, including the Code of Ethics and Substance Abuse Policy, shall constitute grounds for the rejection of my application or denial or revocation of my certification. I understand that NCCCO reserves the right to verify any information in this application or in connection with my certification. I consent to NCCCO's release of any information regarding this application and my examination administration to third parties, consistent with NCCCO's Information Release Policy. I have received a copy of the NCCCO Candidate Handbook, have read it, and agree to be bound by it. I also agree to be bound by all NCCCO policies and procedures, as they may be amended from time to time, including without limitation those posted at nccco.org. I further attest that I am physically and mentally capable of safely operating equipment and/or demonstrating signals on the day of the Practical Examination. I understand and agree that any personal injury and/or property damage resulting from or caused in any way by my participation in the CCO Practical Examination is not and shall not be the responsibility of NCCCO. I understand that if at any point during my certification period I fail to meet any of the requirements outlined above, or if matters arise that can affect my capability to continue to fulfill certification requirements, I must report it to NCCCO immediately and agree to cooperate with any subsequent investigation regarding such matters.

CANDIDATE SIGNATURE

DATE

METHOD OF PAYMENT FOR CANDIDATE EXAMINATION FEES

Do not send cash.

-    Personal check enclosed Employer check enclosed Money order enclosed *Please do not staple your check or money order.*

If paying by credit card, complete the following information:

CREDIT CARD NUMBER

EXPIRATION DATE

NAME (Print as it appears on card)

SIGNATURE (on card)

SECURITY CODE*

* Three- or four-digit code located on the card.

Checks and money orders should be payable to: NCCCO

Please send application and payments to:

NCCCO—Testing Services Department
4141 S. Highland Drive, Suite 225
Salt Lake City, Utah 84124

Phone: 727-449-8525

Fax: 801-938-9540

Email: jhorrocks@nccco.org

CANDIDATE APPLICATION CHECKLIST

- I have completed and signed this *Recertification Exam Application*.
- I have provided credit card information or a check or money order for the correct amount due.
- I have emailed a color digital photo (full face, no sunglasses, no hat) to photos@nccco.org and labeled it with my full name and birth date.
- I do not have a digital photo, so I am attaching a 1 3/8" × 1 3/4" passport photo with this application.

For additional information regarding **recertification**, contact:

National Commission for the Certification of Crane Operators (NCCCO)

2750 Prosperity Avenue, Suite 505

Fairfax, VA 22031

Phone: 703-560-2391

Fax: 703-560-2392

info@nccco.org

www.nccco.org



Change of Address Form

Please use this form to advise of any changes of address. Please mail, fax, or email this completed form to:

NCCCO—Testing Services Department
 1960 Bayshore Blvd.
 Dunedin, Florida 34698

Phone: 727-449-8525
 Fax: 727-461-2746
 Email: info@nccco.org

Please type or print neatly.

FULL LEGAL NAME (as shown on driver's license)	First	Middle	Last	Suffix (Jr., Sr., III)										
CCO CERTIFICATION NUMBER	DATE OF BIRTH		CANDIDATE ID	<table border="1" style="width: 100%; height: 20px;"> <tr> <td style="width: 20px;"> </td> <td style="width: 20px;"> </td> <td style="width: 20px;"> </td> <td style="width: 20px;"> </td> <td style="width: 20px;"> </td> <td style="width: 20px;"> </td> <td style="width: 20px;"> </td> <td style="width: 20px;"> </td> <td style="width: 20px;"> </td> <td style="width: 20px;"> </td> </tr> </table>										

OLD ADDRESS

MAILING ADDRESS			
CITY	STATE	ZIP	COUNTRY
PHONE	EMAIL		
COMPANY / ORGANIZATION	COMPANY PHONE		
COMPANY MAILING ADDRESS			
CITY	STATE	ZIP	COUNTRY

NEW ADDRESS

MAILING ADDRESS			
CITY	STATE	ZIP	COUNTRY
PHONE	EMAIL		
COMPANY / ORGANIZATION	COMPANY PHONE		
COMPANY MAILING ADDRESS			
CITY	STATE	ZIP	COUNTRY

EFFECTIVE DATE OF CHANGE

--



NCCCO Information Release Policy

A. Definitions

1. “NCCCO” means and refers to the National Commission for the Certification of Crane Operators acting through its staff and authorized agents and representatives.
2. “Releasable Information” means and refers to the following information: name, certification status, examination dates, certification dates, certification number(s), and designations.
3. “Third Party” means and refers to an employer, prospective employer, regulatory agency, or any other person or entity that makes an inquiry to NCCCO.

B. Policies

1. It shall be the policy of NCCCO to provide Releasable Information pertaining to individuals who have successfully passed one or more NCCCO examinations. It shall also be the policy of NCCCO to provide Releasable Information pertaining to such individuals on its website using such protocols as may be established.
2. Releasable Information may be released to a Third Party who makes a written request, including by electronic correspondence. Generally, Releasable Information will be released within one business day from actual receipt of a written request.
3. If a Third Party requests information concerning an individual who has not taken or successfully passed an NCCCO examination, NCCCO may release a statement confirming that, as of a given date, the individual does not appear on NCCCO’s list of successful candidates in one or more categories of certification.
4. If an applicant or certificant is under formal sanction, suspension, or revocation by NCCCO, then NCCCO may release a statement to that effect to any persons and by any reasonable means, including by means of a list published on the NCCCO website. In addition, if an individual applicant or certificant is under formal investigation, sanction, suspension, or revocation by NCCCO, then NCCCO may release a statement concerning the status of the applicant or certificant to any Third Party and to any jurisdiction that requires or accepts CCO certification as a basis for satisfying requirements to work in the jurisdiction. Any such statement to a Third Party or jurisdiction may identify the applicant or certificant, the certifications affected,

the actions taken, and the effective dates of any such actions.

5. If a Third Party seeks information other than the foregoing information, generally, absent a subpoena or similar legal process, such information will not be released. However, in the course of business, as circumstances reasonably warrant, NCCCO reserves the discretion to release information other than the foregoing information.
6. Certain situations may require or warrant the immediate verbal confirmation of an individual’s certification status or other Releasable Information in response to a written or verbal request. Under such circumstances, NCCCO may provide such immediate verbal confirmation, at its discretion. When such a verbal confirmation is provided, it shall be NCCCO’s policy to follow up with a written confirmation.
7. It shall be the policy of NCCCO to discuss score-related and test-specific matters only with a candidate or a candidate’s authorized legal representative.
8. NCCCO will release Releasable Information about an individual upon receipt of a written request (including electronic correspondence) from that individual. NCCCO may release information other than Releasable Information about an individual, at its discretion, upon receipt of a signed, notarized, written request from that individual. In addition, NCCCO will release information other than Releasable Information about an individual when required by a legal authority of competent jurisdiction under a duly-issued subpoena, subject to any objection, or as otherwise required by law.

IMPORTANT CONTACT INFORMATION



NATIONAL COMMISSION FOR THE CERTIFICATION OF CRANE OPERATORS

2750 Prosperity Avenue, Suite 505
Fairfax, VA 22031-4312

Phone: 703-560-2391

Fax: 703-560-2392

Email: info@nccco.org



**NATIONAL COMMISSION FOR THE
CERTIFICATION OF CRANE OPERATORS**

2750 Prosperity Avenue, Suite 505
Fairfax, VA 22031-4312

Phone: 703-560-2391

Fax: 703-560-2392

info@nccco.org

www.nccco.org